



LEDTECH ELECTRONICS CORP.

NANYA ROAD, MUGANG ZHAOQING  
CITY GUANGDONG CHINA.

TEL: 86-758-2875541, 2870651, 2877464, 2876185, 2877017

FAX: 86-758-2878014

*Http://www.ledtech.com.tw*

# SPECIFICATION

*PART NO. : LT8A32-54-T5*

**0603 SMD CHIP LED**



Approved by

Checked by

Prepared by

*Tung*

*Andy*

*Karen*

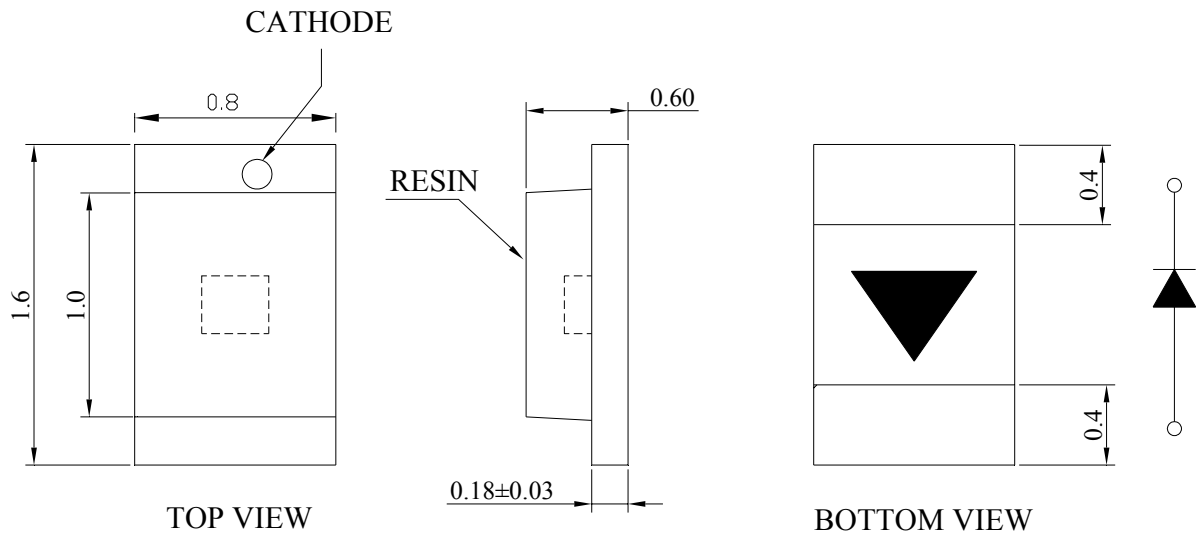
**Package Dimensions**

**Notes:**

1. All dimensions are in mm.
2. Tolerance is  $\pm 0.1$  mm unless otherwise noted.

**Description**

Part No.	LED Chip		Lens Color
	Material	Emitting Color	
LT8A32-54-T5	GaAsP/GaP	Yellow	White diffused

**Absolute Maximum Ratings at Ta=25 °C**

Parameter	Symbol	Rating	Unit
Power Dissipation	P <sub>D</sub>	78	mW
Reverse Voltage	V <sub>R</sub>	5	V
D.C. Forward Current	I <sub>f</sub>	30	mA
Peak Current(1/10Duty Cycle,0.1ms Pulse Width.)	I <sub>f</sub> (Peak)	80	mA
Operating Temperature Range	T <sub>opr.</sub>	-30 to +80	°C
Storage Temperature Range	T <sub>stg.</sub>	-40 to +85	°C
Soldering Temperature.	T <sub>sol.</sub>	Reflow Soldering:260°C for 10 sec.	

**Electrical and Optical Characteristics:**

Parameter	Symbol	Condition	Min.	Typ.	Max.	Unit
Luminous Intensity	I <sub>v</sub>	I <sub>f</sub> =20mA		6.5		mcd
Forward Voltage	V <sub>f</sub>	I <sub>f</sub> =20mA		2.1	2.6	V
Peak Wavelength	λ <sub>p</sub>	I <sub>f</sub> =20mA		585		nm
Dominant Wavelength	λ <sub>d</sub>	I <sub>f</sub> =20mA		590		nm
Reverse Current	I <sub>r</sub>	V <sub>r</sub> =5V			100	μA
Viewing Angle	2θ 1/2	I <sub>f</sub> =20mA		140		deg
Spectrum Line Halfwidth	Δλ	I <sub>f</sub> =20mA		35		nm

Notes:1. The datas tested by IS tester.

2. Customer's special requirements are also welcome.

**Typical Electrical/Optical Characteristic Curves**

**(25°C Ambient Temperature Unless Otherwise Noted)**

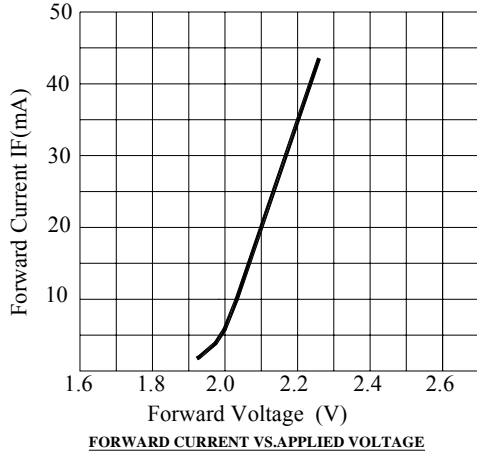

FORWARD CURRENT VS. APPLIED VOLTAGE

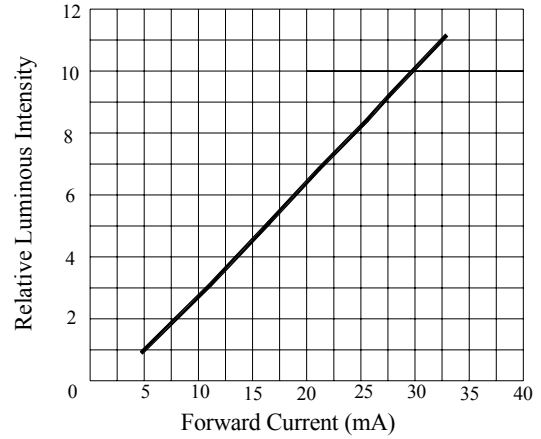

RELATIVE INTENSITY VS. FORWARD CURRENT

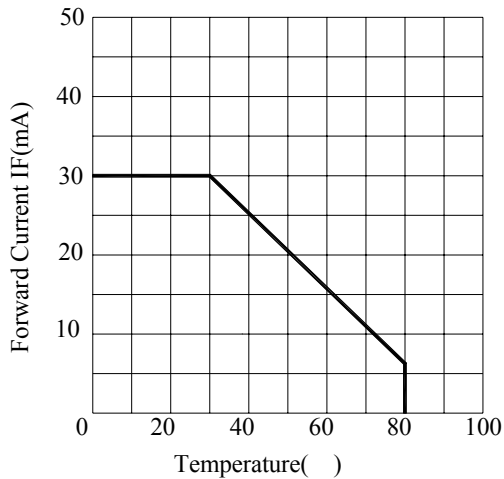

FORWARD CURRENT VS. AMBIENT TEMPERATURE

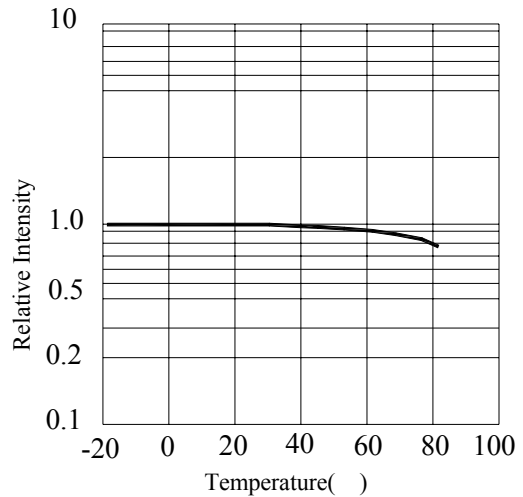

RELATIVE INTENSITY VS. AMBIENT TEMPERATURE

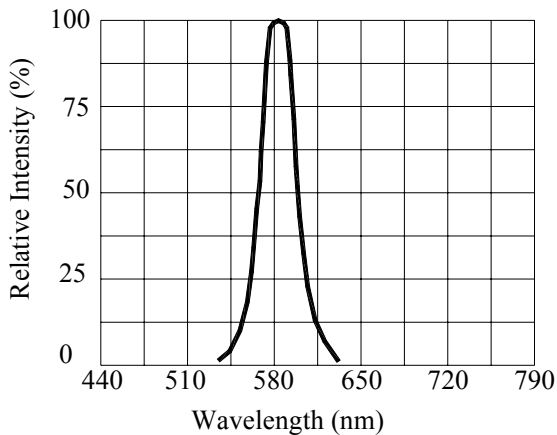

RELATIVE INTENSITY VS. WAVELENGTH

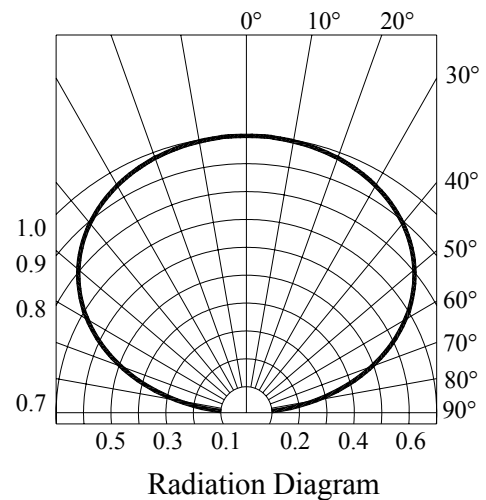

Radiation Diagram

## Precautions in Use:

### Storage

Recommend storage environment

Temperature : 5 30 (41°F 86°F)

Humidity : 60% RH Max.

Use within 7 days after opening of sealed vapor/ESD barrier bags.

If the moisture absorbent material (silica gel) has faded away or the LEDs have exceeded the storage time, baking treatment should be performed using the following conditions. Baking treatment :  $60 \pm 5$  for 24 hours.

Fold the opened bag firmly and keep in dry environment.

### Soldering

#### Reflow Soldering

Recommend use of upper and lower heater type reflow furnace.

260°C Max for up to 10 seconds, one time only.

Pre-heat is 150°C Max for up to 2 minutes Max.

In case of screen-printing, keep metal mask thickness between 0.2mm and 0.3mm.

### Cleaning

Surface condition of this device may change when organic solvents such as trichloroethylene or acetone were applied.

Avoid using organic solvent.

Recommend ultrasonic method 300W Max.

### Packaging

EIA-481A standard package.

In 8mm tape on 4000 pcs diameter reels sealed in vapor/ESD barrier bags.

### Reflow Temp/Time:

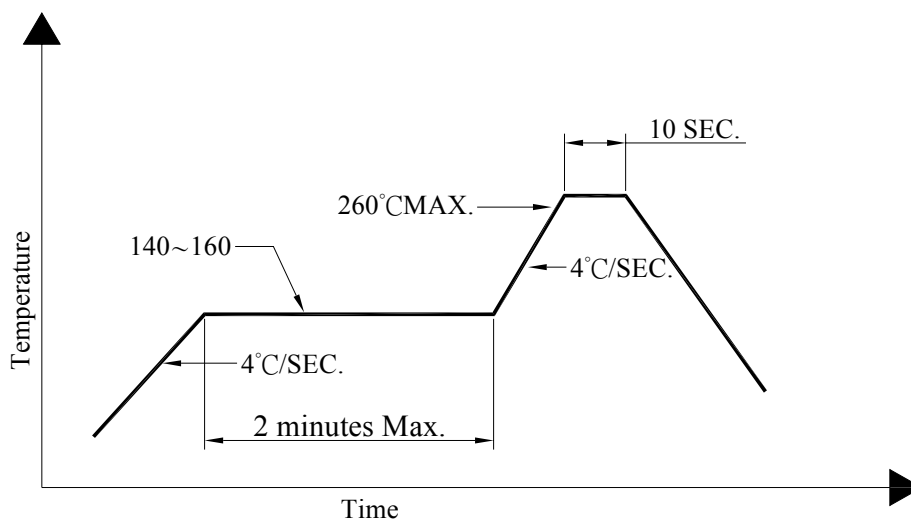

### Reflow Soldering Pad Dimensions

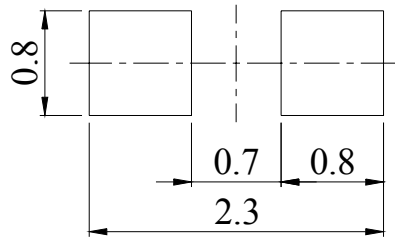

### Dimensions for Tape

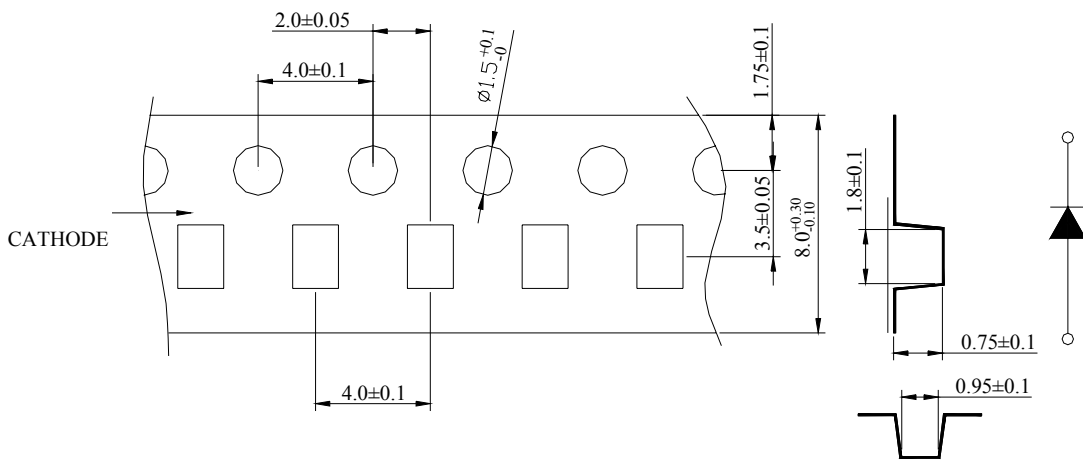

### Dimensions for Reel

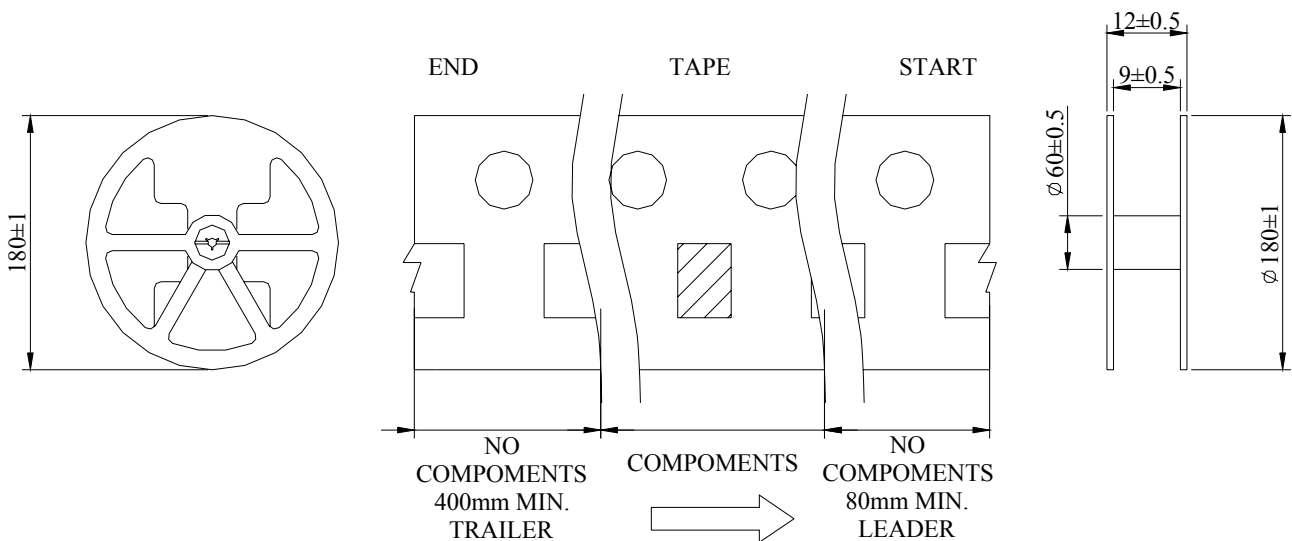

#### Notes:

1. All dimensions are in mm, tolerance is  $\pm 2.0$  mm unless otherwise noted.
2. Specifications are subject to change without notice.

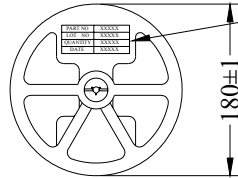
**Dimensions for Tape**
**Reel : 4,000PCS**

PART NO	XXXXX
LOT NO	XXXXX
QUANTITY	XXXXX
DATE	XXXXX
BIN CODE	XXXXX

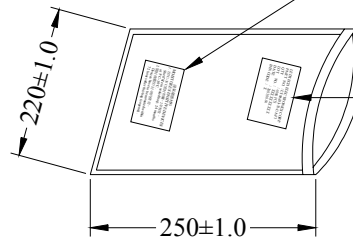
**Bag : 4,000PCS**

溼氣敏感材料  
**MOISTURE SENSITIVE DEVICES**  
 1. 在5°C-30°C密封貯藏，2年有效。  
 Shelf life in sealed bag : 24 months  
 at 5°C~30°C.  
 2. 開封後需在168小時內使用。  
 Devices have to be mounted within  
**168** hours after this bag is opened .

PART NO	XXXXX
LOT NO	XXXXX
QUANTITY	XXXXX
DATE	XXXXX
BIN CODE	XXXXX

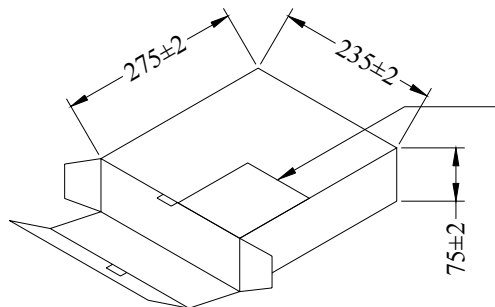
**5 Bags : 20,000PCS**

PART NO	XXXXX
LOT NO	XXXXX
BIN CODE	XXXXX
QUANTITY	XXXXX
DATE	XXXXX

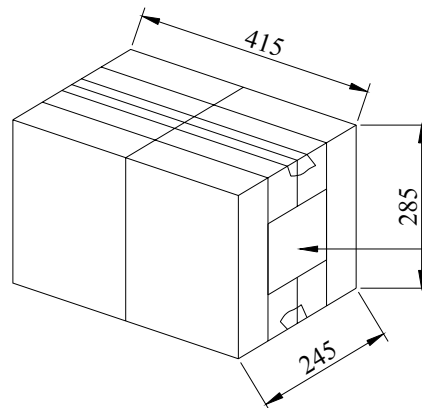
**5 Boxes : 100,000PCS**

C/T NO	XXXXX
PART NO	XXXXX
QUANTITY	XXXXX
N. W.	XXXXX
G. W.	XXXXX
REMARK	XXXXX

**Notes:**

- 1.7 inch reel-4000 pieces per reel.
- 2.Minimum packing quantity is 500 pieces for remainders.
- 3.The maximum number of consecutive missing lamps is two.